

MPT-8C Electrical Wiring

Solid State Instruments by Radian Research, Inc, 3852 Fortune Dr, Lafayette, IN 47905 (765)449-5576

Mail: technicalsupport@radianresearch.com

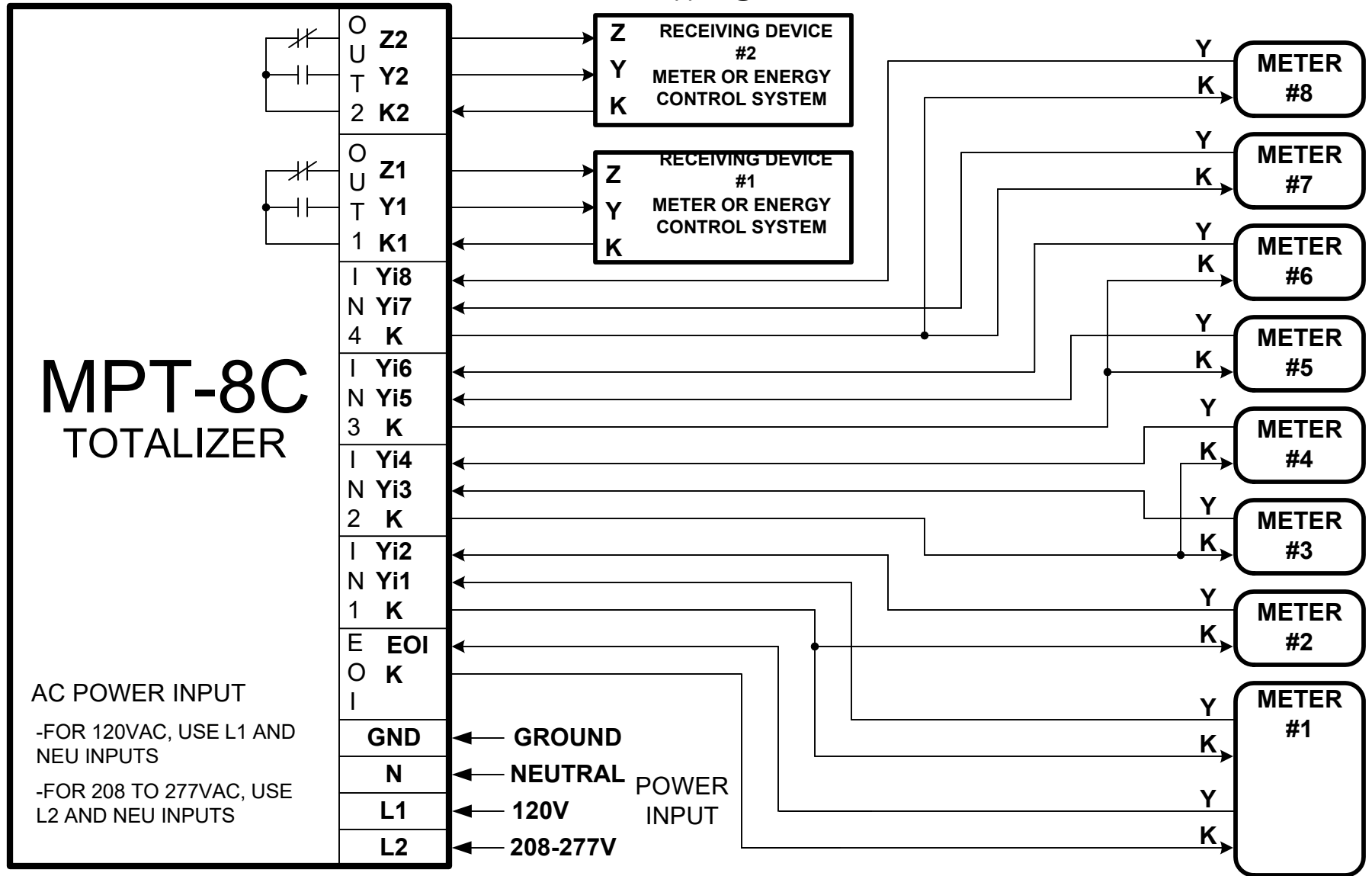

NOTE: A Sense Voltage of +13VDC is applied to the meters via the "Y" leads from the MPT-8C. The "K" lead is the common return.